

# OPERATING INSTRUCTIONS

## ELR 600



### FEATURES :

- Monitors true RMS earth fault currents (upto 30A)
- Sensitivity ( $\Delta I_n$ ) & time delay ( $\Delta t$ ) adjustable
- LED indication for measured leakage current and various user settings
- 'Test' and 'Reset' functions
- CBCT Open circuit indication
- Two relay outputs : Protection relay and Fail safe relay

### SPECIFICATIONS

- 1. FUNCTION**  
Monitoring of earth fault currents in 3 $\phi$  4 wire or single  $\phi$  systems
- 2. SUPPLY VOLTAGE**  
230 VAC, 415 VAC (Separate model) ( $\pm 15\%$ )  
AC:50 Hz/60 Hz
- 3. MONITORED LEAKAGE CURRENT**  
30mA to 30A with CT ratio 1200:1
- 4. SENSITIVITY ( $\Delta I_n$ )**  
30, 100, 300, 500mA & 1, 3, 5, 10, 20, 30Amp

- 5. TRIP LEVEL LIMITS**  
95% to 105% of set value  
All LEDs glows after set trip time is over
- 6. TIME DELAY**  
0 to 9 seconds
- 7. RESET TIME**  
~1 sec.
- 8. LED INDICATION**
  1. **YELLOW:** Power ON indication
  2. **RED(Full ON):** Tripped indication
  3. **Three green LEDs(blinking):** CBCT error / CBCT absent
  4. **Three green LEDs** showing leakage Current condition (25%, 50% and 75%)
- 9. TEST/RESET FACILITY**
  1. Front panel
  2. Remote (through terminal contact)
  3. Reset on power interruption
- 10. RESET ENABLE LEVEL**  
Below 85% of tripped level & in presence of CBCT
- 11. MINIMUM TRIGGER TIME**  
125 msec.
- 12. CBCT RATIO**  
1200:1
- 13. POWER CONSUMPTION**  
3 VA
- 14. OUTPUT RATING**
  1. Trip Relay:  
1 SPDT: NO(5A @ 250V AC)  
NC(3A @ 250V AC) & Com.
  2. Fail safe relay:  
1 SPST: NO(10A @ 250V AC) & Com.
- 15. ACCURACY**  
 $\pm 5\%$  with respect to full scale
- 16. MEMORY**  
Storage of the leakage fault (fault clear by pressing 'Reset' or on power interruption)
- 17. MOUNTING**  
Din Rail Mounting (size 35mm)
- 18. HOUSING**  
3M

- 19. TEMPERATURE**  
Operating: 0 to 50 °C  
Storage : 0 to 75 °C
- 20. HUMIDITY**  
Upto 95% RH ( Non-condensing)
- 21. WEIGHT**  
228 gms.

### SAFETY SUMMARY

All safety related codifications, symbols and instructions that appear in this operating manual or on the equipment must be strictly followed to ensure the safety of the operating personnel as well as the instrument.

If the equipment is not handled in a manner specified by the manufacturer it might impair the protection provided by the equipment.

**⚠ CAUTION:** Read complete instructions prior to installation and operation of the unit.

### WIRING GUIDELINES

**⚠ CAUTION**

1. To prevent the risk of electric shock power supply to the equipment must be kept OFF while doing the wiring arrangement.
2. Wiring shall be done strictly according to the terminal layout with shortest connections. Confirm that all connections are correct.

**⚠ CAUTION**

1. To ensure the safe operation of unit, check the wiring and connections.
2. It is recommended to test the unit periodically to satisfy the regulations.

### TERMINAL CONNECTIONS

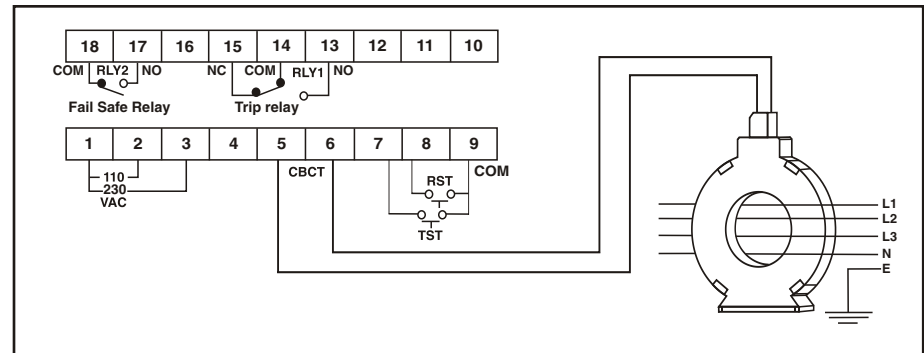

### DIMENSIONS (All dimensions in mm)

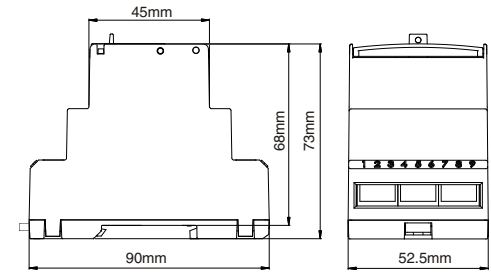

### LED BARGRAPH

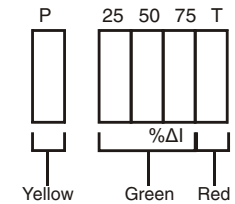

### NOTE FOR CONNECTION

For single phase applications, only the live and neutral needs to be passed through the CBCT. The Earth MUST NOT pass through the CBCT.

The distance between relay and CBCT should be kept as short as possible

Use screen, shielded cable or twisted pair cable between the unit & CBCT for long distance (Greater than 1m).

## CORE BALANCED CURRENT TRANSFORMER

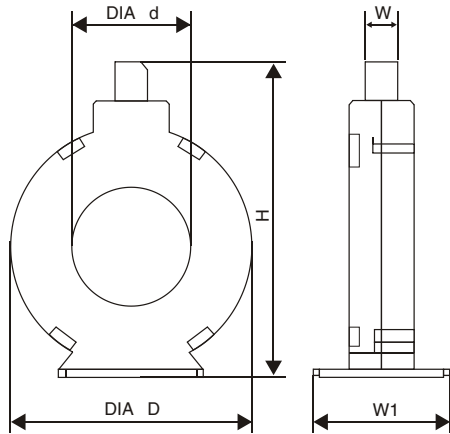

CBCT TYPE	Dimensions (mm)				
	D	d	H	W	W1
35	64	45	96	13	52.5
70	98	82	131	13	87
120	149	125	184	13	122
STD. TOL.	2 - 3	5 - 6	-	1.5 - 2	-



CT Type ZPC (Zero Phase Current)

### MODES OF OPERATION

- 1) Turn power ON
- 2) The yellow "supply ON" LED will illuminate and all other LEDs flash for a while.

#### 1. Test mode

The unit can be placed into a fault condition by pressing the "Test" button on the front of the unit (or by shorting terminals 7 & 9).

Key press	Display	Description
Press 		In test mode, all LEDs illuminate & trip relay energises after set trip time is over, indicating proper operation of unit.

#### 2. Normal Operating mode

Current range is set using knob of indication  $\Delta i$  (A)

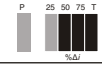
Key press	Display	Description
NONE		For eg. If $\Delta i$ (A) = 10Amp & Leakage current = 2.5Amp then LED '25' (green) glows

- A. For leakage current level < 25% - All bargraph LED's off
- B. For leakage current level > = 25% - LED '25' glows
- C. For leakage current level > = 50% - LED '25' & '50' both glow
- D. For leakage current level > = 75% - LED '25', '50' & '75' glow
- E. For leakage current level 95 to 105% - All LEDs glow after set trip time is over

Protection relay is energised & fail safe relay is de-energised after set time delay is over.  
**NOTE:** At CBCT error condition, red LED stays continuously ON and other 3 green LEDs keep blinking.

#### 3. To reset the unit

Press the 'Reset' button on the front of the unit or short terminals 8 & 9 to reset the unit

- NOTE:** 1. Applicable only when unit is in tripped condition & leakage current is less than 85% of tripped level  
 2. The 'Reset' button does not work in the absence of CBCT.

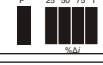
Key press	Display	Description
Press 		All LED's are switched off indicating output relay's "non tripped state"

### USER GUIDE

#### Significance of the Test button

Test button is used to check the proper functioning of the unit even in the absence of leakage current. ie. To check the proper functioning of unit when there is no leakage current & CBCT connected to unit press the test button. On pressing test button, all LEDs glow after set trip time is over showing that the unit is working properly.

**NOTE:** At CBCT error condition, red LED stays continuously ON and other 3 green LEDs keep blinking.

#### Significance of the Reset button

When there is leakage current above the set value of current unit trips ie all LEDs illuminate. At that time to reset the unit to prior to the fault condition press reset button.

#### Reset enable level

When leakage current increases above the set value of current unit trips & all LEDs glow indicating trip of the unit. At that time to reset the unit to previous condition (ie prior to trip condition) leakage current should be minimise to less than 85% of set value. This value is known as reset enable value at which unit can reset.

#### Fail safe relay:

Fail safe relay ensures the proper working of unit at the fault situation i.e. it doesn't allow the fault occurred in the unit propagate ahead and gets de-energised to avoid the damage due to over current.

#### Trip relay (Protection relay):

When leakage current exceeds the set value, fail safe relay de-energised & trip relay energised and doesn't allow the further increment of leakage current by breaking the power supply to the load. It is for protection of the unit from over current so it is also called as a protection relay.

#### Trip time delay

The time taken by unit to trip when fault occurs is called trip time delay. The time delay should be long enough to avoid nuisance tripping caused by harmless transients, yet fast enough to open the circuit when a hazard exists.

(Specifications subject to change as development is a continuous process).

#### Selec Controls Pvt. Ltd., India.

(Formerly Selectron Process Controls Pvt. Ltd.)  
 Tel: 91-22-28476443 / 28471882, Fax: 91-22-28471733,  
 Website: www.selecindia.com E-mail: sales@selecindia.com